

# Multisensor

Issue 2019

Coordinate metrology with optics, computed tomography and multisensor technology is gaining in importance

TomoScope® FQ

TomoScope® XS Plus

WinWerth® TomoAssist

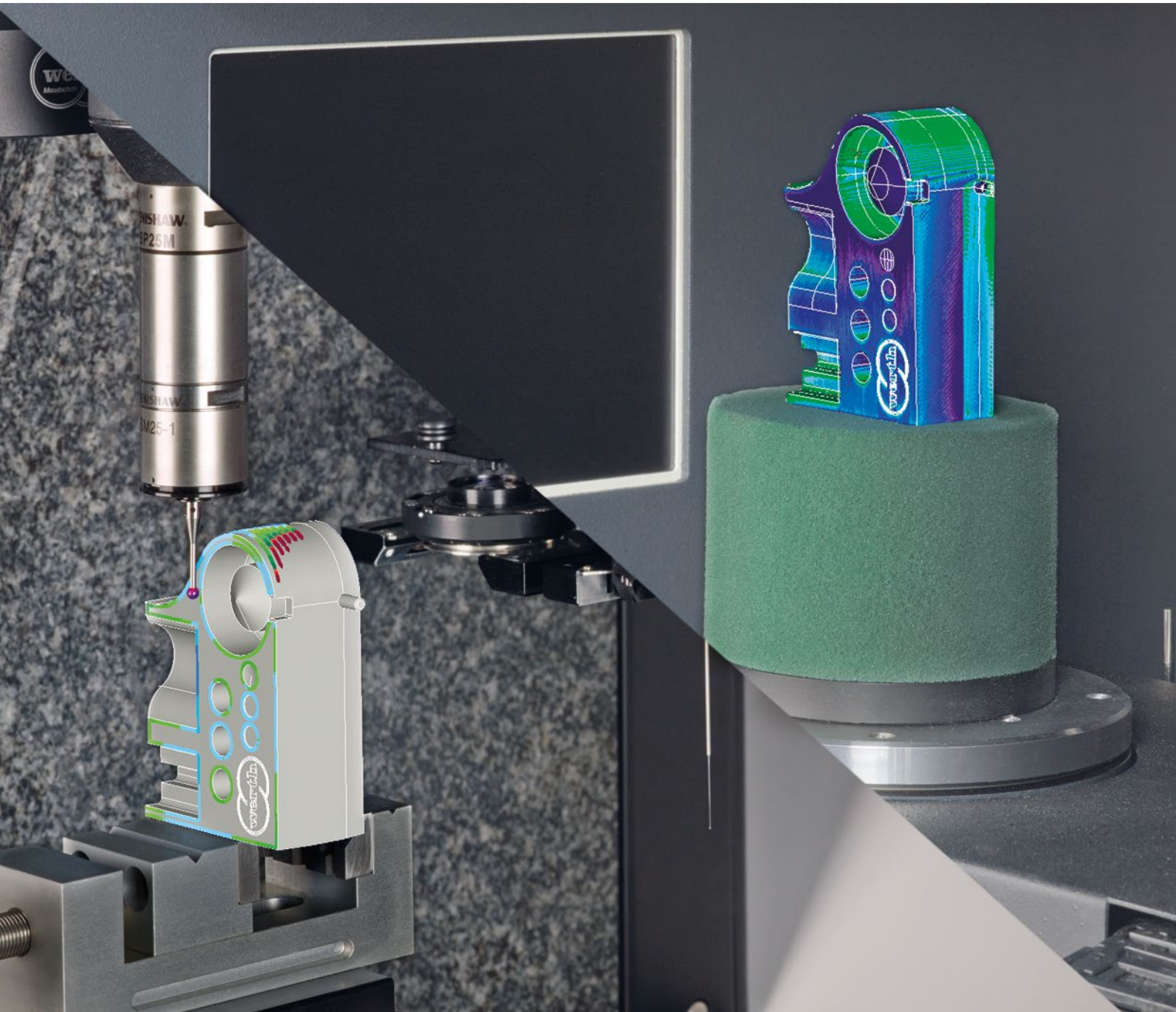

**Title**

*Multisensor technology or computed tomography?  
Complete measurement of complex workpieces  
by combination of optical and tactile sensors  
or with computed tomography*



*The new TomoScope® XS Plus enables the measurement of larger workpieces up to approximately 450 mm length and smaller objects with high resolution or reduced measuring time.*

## Coordinate metrology with optics, computed tomography and multisensor technology is gaining in importance

The vision of autonomous manufacturing processes becomes reality. Production and quality assurance are networked with each other in control loops, and modern products offer an ever-increasing range of functions in a smaller space. For this, among other things, extensive information about the workpiece and thus a complete measurement of more complex geometries are required. The Werth coordinate measuring machines with optical sensors, X-ray tomography or multisensor technology offer the best prerequisites for this. This was one of the reasons for our successful corporate development. Twenty-five years have passed since Werth left a conglomerate and was able to align its corporate strategy more directly to the customer's requirements. The Werth team, which has grown strongly during this period, provides top performance worldwide in development, production and customer service. In the past fiscal year, our work was rewarded by another 30 percent increase in incoming orders. In total, Werth Messtechnik GmbH has increased its business volume fifteenfold in the last 25 years.

Following the trends mentioned above, the focus of our product innovations this year will once again be on complete capturing of workpieces and the integration of coordinate metrology into production. In addition, new modules of our WinWerth® measurement software simplify process sequences and reduce set-up and evaluation times.

Coordinate measuring machines with optical sensors, in particular multidimensional distance sensors such as the Chromatic Focus Line sensor, enable the necessary fast capturing of many measurement points. The now introduced combination of this sensor with a rotary/tilt axis extends the scope of functions to the measurement of complex three-dimensional workpieces. Computed tomography uses multipoint measurement to capture the entire workpiece, including the internal geometries. This year, we will introduce two new CT machines. Following the worldwide success of the TomoScope® XS, we present the TomoScope® XS Plus, the next-generation compact machine. With the TomoScope® FQ series we have developed a concept for the integration of coordinate measuring machines with computed tomography into the production line, also in combination with multisensor coordinate measuring machines.

To simplify the process, various software modules have been integrated into our measurement software. WinWerth® TomoAssist allows fast and reliable tomography by automatically determining the optimal CT settings. Regardless of the operator experience, the procedure guarantees good repeatability with a short measuring time. WinWerth® FormCorrect enables process optimization in plastic injection molding or 3D printing and reduces development costs by correcting the CAD model directly in the measuring software.

Optics, computed tomography or multisensor technology – offline, atline or inline application: At Werth, you almost always have the right coordinate measuring technology at your disposal.



Dr. Ralf Christoph  
President and Owner  
Werth Messtechnik GmbH

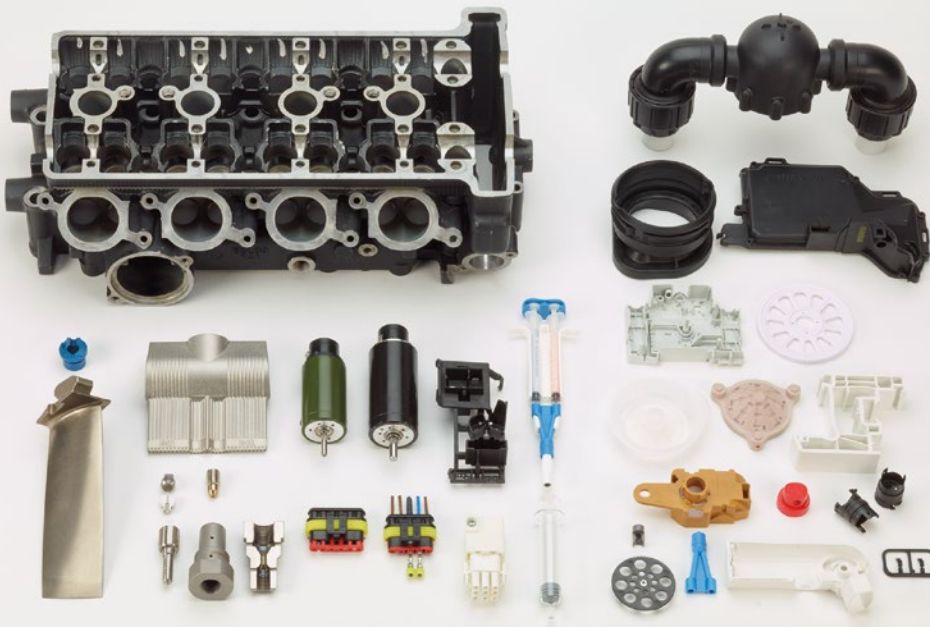

8

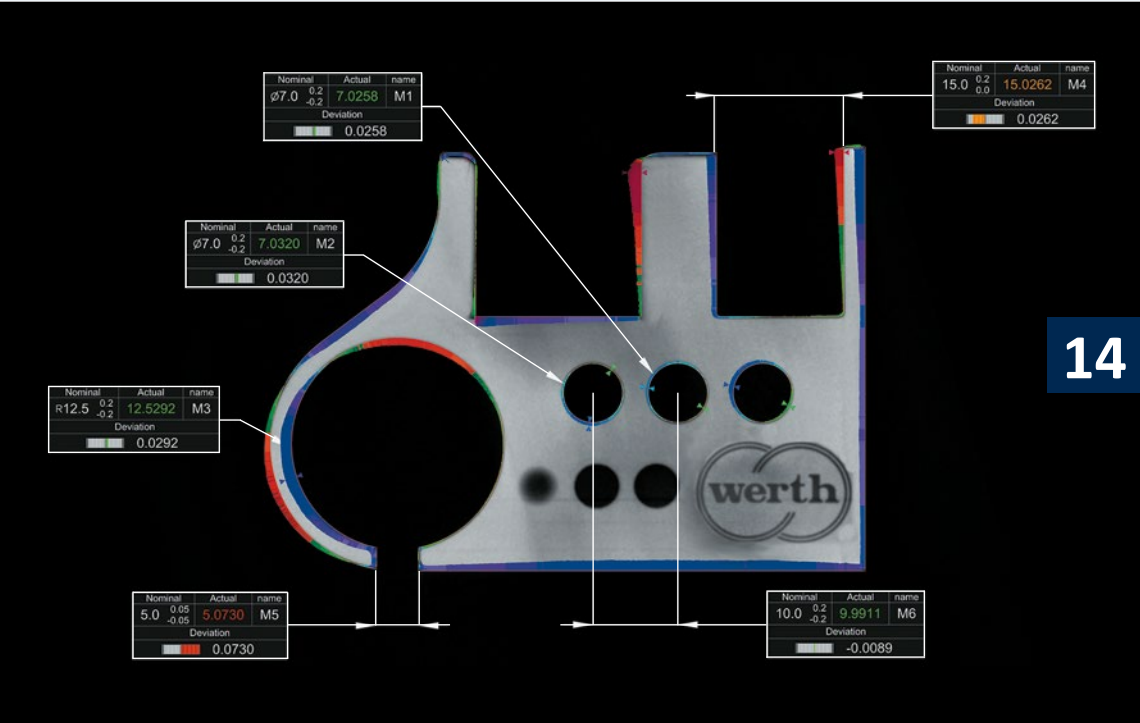

14

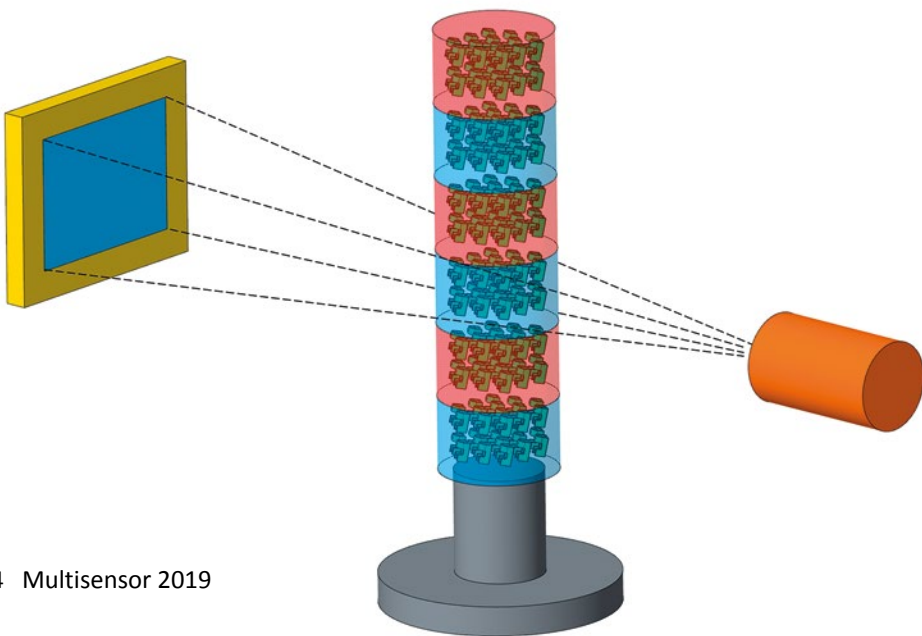

28

# Contents

Coordinate metrology with optics, computed tomography and multisensor technology is gaining in importance	2	PLATO – Introduction to measurement software with tutorials	22
Contents	4	Greater flexibility for tool correction	23
Computed tomography for inline applications	6	Werth subsidiaries introduce themselves – Werth Messtechnik France SARL	24
Optimal tomography in just a few steps	8	Highly accurate, rapid measurement in any orientation	26
Traceability of coordinate measuring machines compliant with IATF 16949	10	Complete measurement of plastic gears	27
Our field service	12	TomoScope® XS Plus – Compact machine with large measuring volume	28
WinWerth® 9.43 – New functions for rapid measuring and editing	14	Werth international – News	30
Greater transparency in the voxel volume	15	New logistics center in Giessen Promotion of young talent	31
Summertime family fun at Werth	16	Credits	32
One four-thousand meter summit each for everyone	17		
Highly accurate quality assurance (application report)	18		

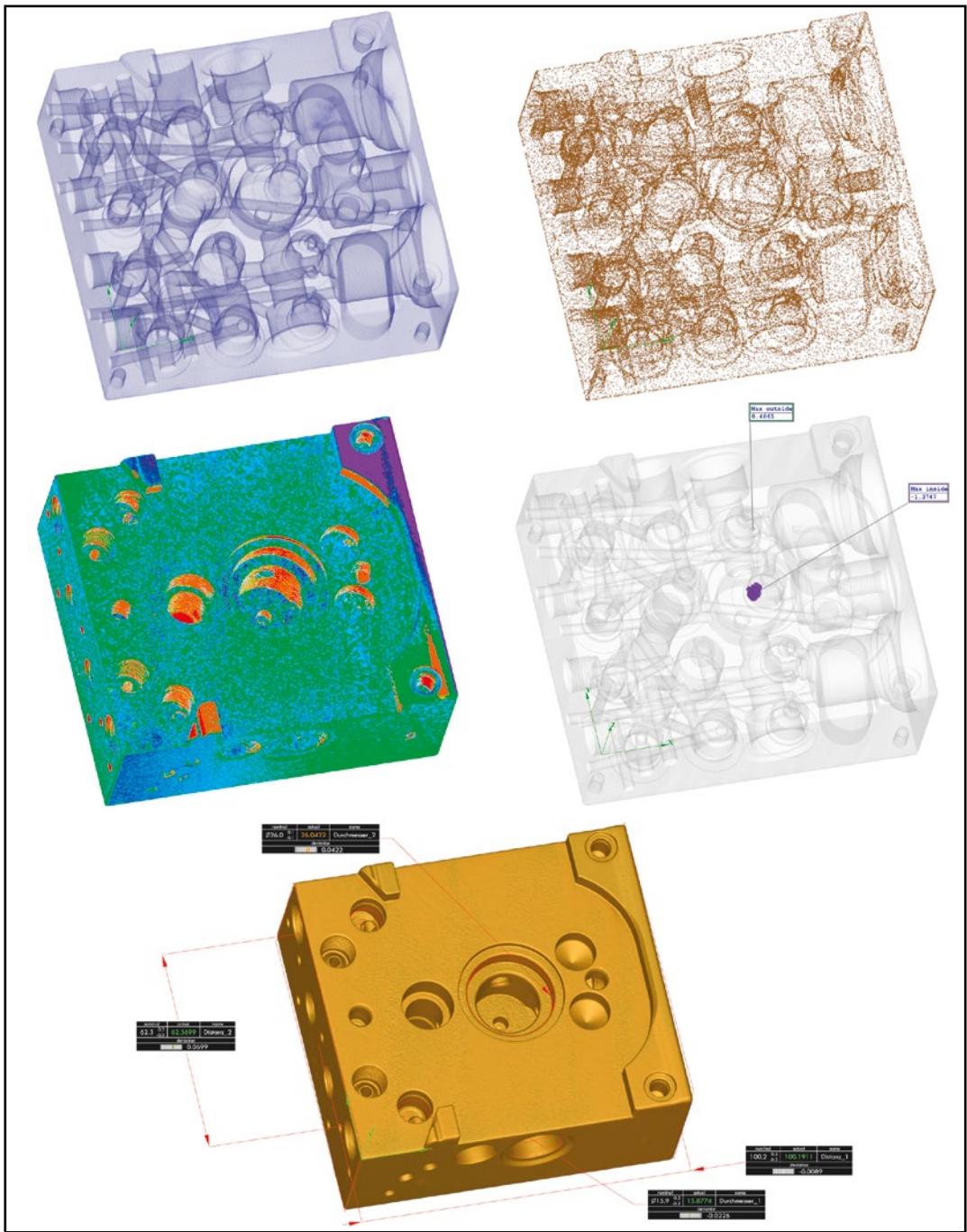

Volume (top left), measuring point cloud (top right), color-coded deviation plot of the measuring point cloud in comparison to the CAD model (center left), color-coded representation of voids and cavities by volume size (center right) and dimensions (below)



Network of Werth ScopeCheck® S and TomoScope® FQ for inline measurements with multisensor technology and computed tomography in 30-second cycles

## Computed tomography for inline applications

The high-power X-ray tube of the new Werth TomoScope® FQ (Fast Qualifier) series has a power of more than 1.5 kW. This allows for a shorter exposure time for each X-ray image and thus for measurements with computed tomography (CT) in tens of seconds. The integration of a shutter eliminates the time-consuming starting cycles of the X-ray source. This also results in an extended service life, as wear is significantly reduced. The maintenance-free X-ray tube ensures a high uptime. With the acceleration voltage of 225 kV or optionally 300 kV, even dense materials and large workpieces can be measured.

For inline measurements, the measuring programs can be prepared remotely from the machine at an offline workstation. The workpieces can be inserted into the safety area around the robot via a conveyor belt. There the measuring machines are loaded automatically. CT coordinate measuring machines record X-ray images of the workpiece in different rotational positions and combine them to form a complete workpiece volume including internal geometries. Measuring points at the material transitions are determined using a patented sub-voxeling process. The measuring and evaluation process is then started, for example, by means of a QR code scanner. The workpieces can also be identified later via the QR code.

The new TomoScope® FQ series allows for an up to 50 times faster calculation and evaluation of the measuring

point cloud. In a production cycle of 30 seconds, geometric properties are checked and an actual-to-actual comparison is carried out in order to check the workpieces for defects.

In the WinWerth® Scout user interface, a list of the measured workpieces can be displayed at all workstations in the network. WinWerth® Scout enables a fast and simple check of the measurement results, for example by the shift supervisor. Workpieces that lie outside the tolerances are marked in color. Measurement and inspection take place in the same software so that the traceability of the results is guaranteed throughout, and only one software license is required. The uniform software also enables task sharing between CT and multisensor coordinate measuring machines. The measurement results of all coordinate measuring machines for a workpiece are documented in a common protocol.

Inline measurements with computed tomography are not only advantageous for complex geometries but also for large quantities and heavy workpieces such as valve blocks, housings and castings. With the Werth TomoScope® FQ series such workpieces can be measured in approx. 30 seconds. A measurement in one run of multiple smaller workpieces is also extremely time-saving. This results in a typical measuring time of 1.5 seconds per workpiece.

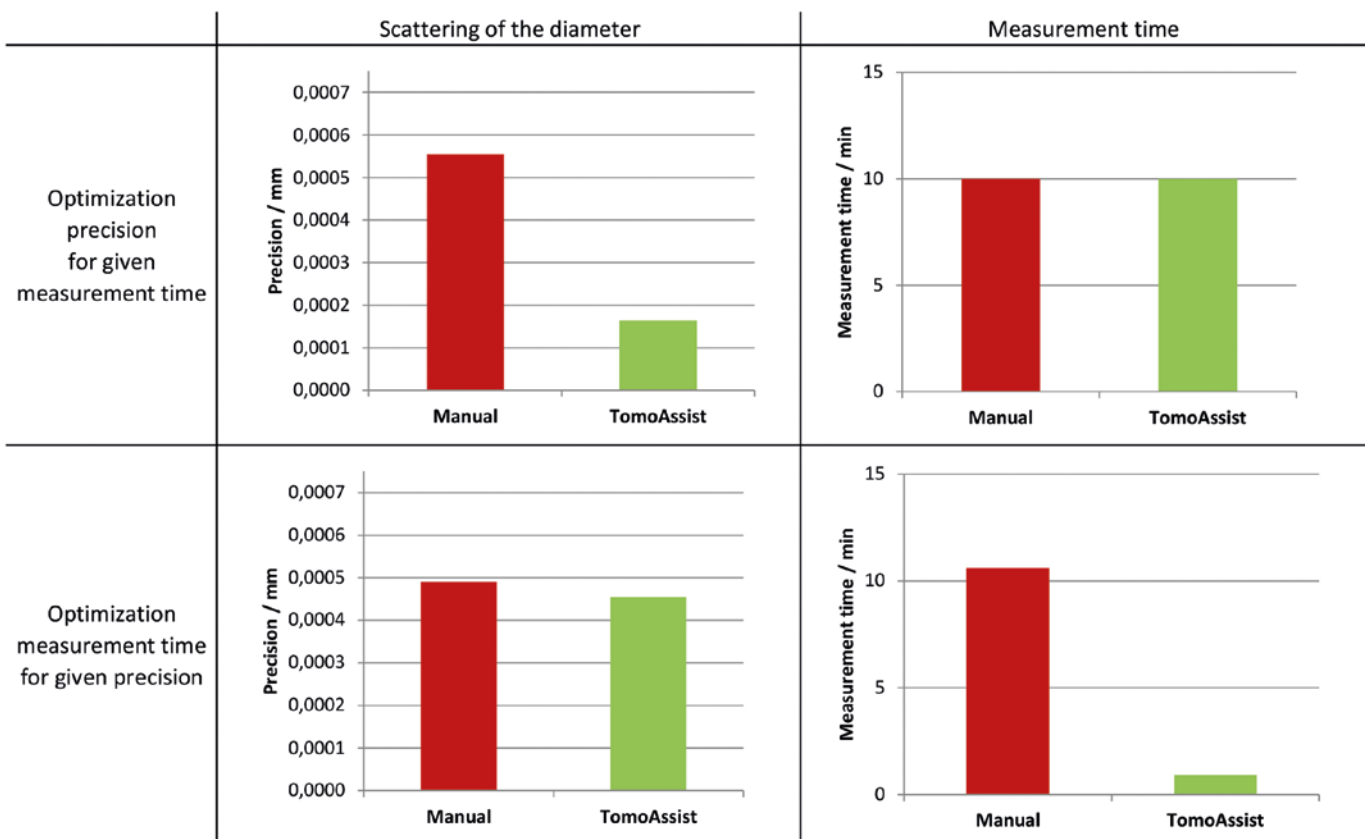
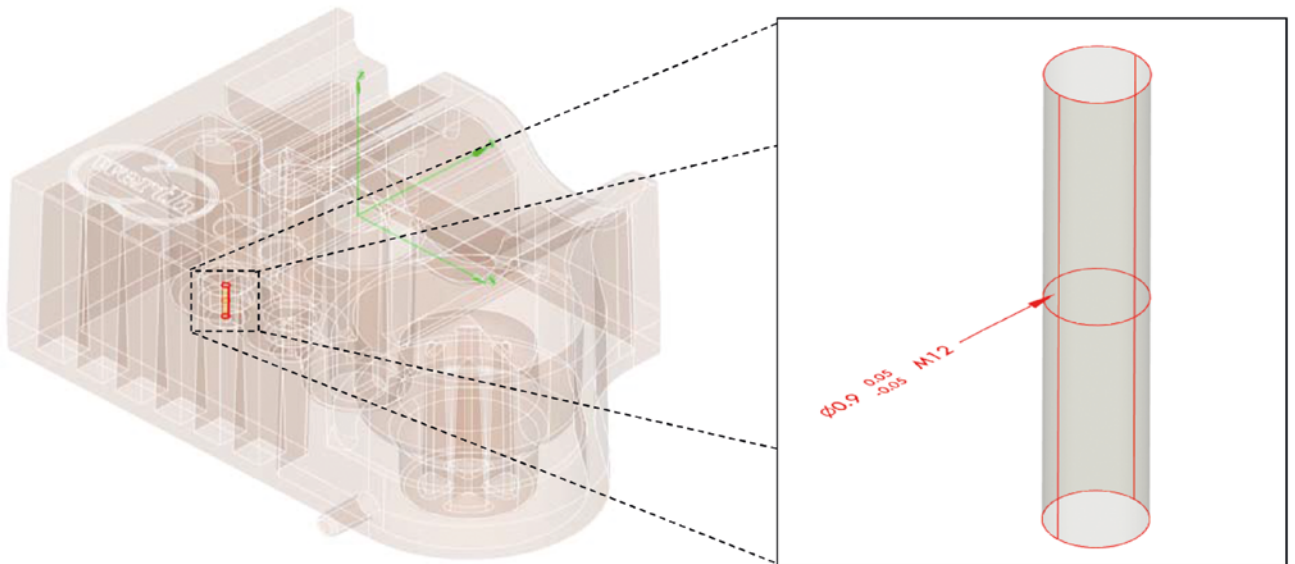

Optimization of precision for a given measurement time (top): The automatic setting algorithm of WinWerth® TomoAssist guarantees better precision (green) than the human being (red) for the same measurement time.

Optimization of the measurement time with specified precision (bottom): The automatic setting algorithm in WinWerth® TomoAssist guarantees a shorter measurement time (green) than the human being (red) with the specified precision.

Although the operator accepts a longer measurement time to be on the safe side, TomoAssist achieves better precision.



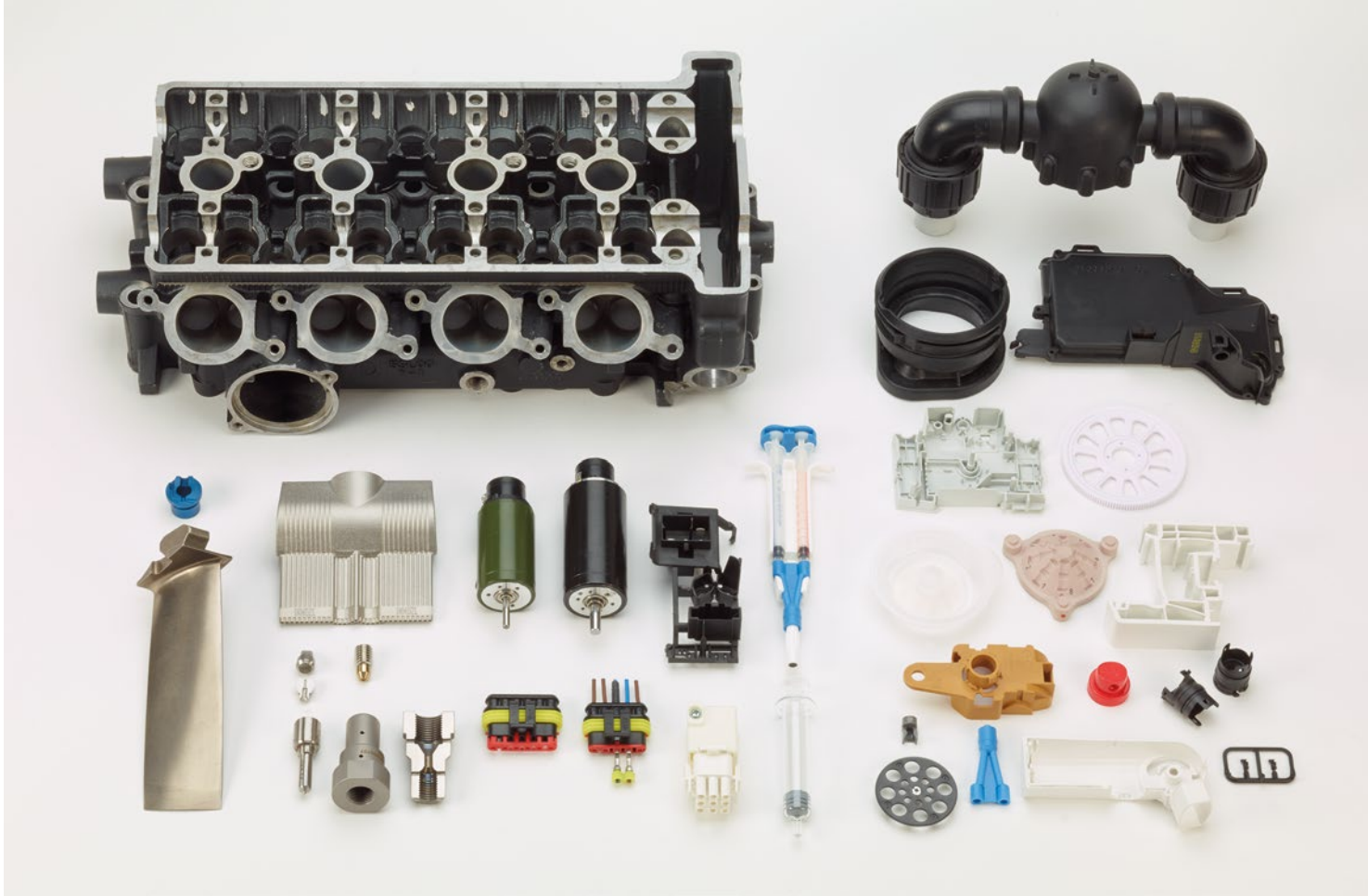

*Today many different workpieces can be measured with computed tomography, such as those with high-density (left), multi-material structure (center) and also with complex plastic injection molding geometries (right).*

## Optimal tomography in just a few steps

With the new WinWerth® TomoAssist software module, TomoScope® and TomoCheck® machines are even easier to use. TomoAssist automatically determines the optimal CT setup parameters for a particular measurement task. Suggestions are made for the tube power, voltage, hardware filters, exposure time, and number of projections. The new process takes into account the workpiece properties such as geometry, orientation, and material as well as the structural resolution required, based on the critical inspection dimensions. With WinWerth® TomoAssist, any user can achieve good reproducibility with short measurement times, regardless of experience level.

When the precision of the measurement values is specified, for example given by the workpiece manufacturing tolerances, the parameters are automatically set to minimize the measurement time. An estimate of the measurement time is provided. The time savings minimize inspection costs. If the measurement time is specified, as is often the case when defined by the manufacturing cycle time, the precision is automatically

optimized and the expected value is provided. Complicated and expensive test measurements can be avoided in this way, and the machine can be put to use efficiently. Any user can determine the optimal tomography parameters in just a few steps without needing expert knowledge.

Experienced users can also use WinWerth® TomoAssist to adjust individual parameters specifically when the boundary conditions change. The tube power level can be maximized for a given structural resolution, for example. Optimizing the voltage and hardware filter ensures high contrast and low noise. Both make it possible to either improve reproducibility or reduce measurement time. By optimizing the exposure time and the number of rotary steps, the measurement time is reduced to the minimum necessary.

WinWerth® TomoAssist covers a wide variety of applications, from first article inspection to the creation and optimization of measurement sequences.

## Chain for DAkkS calibration of coordinate measuring machines

The meter is defined as the length of the line segment that light passes through in a vacuum during  $1/299\,792\,458$  seconds

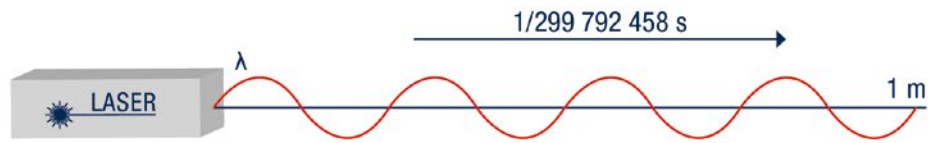

Calibration of standards by national metrology institutes or DAkkS laboratories



Calibration of the machines with calibrated standards



Traceable measurements



*Based on the definition of the meter, different length standards are calibrated by national metrology institutes or DAkkS laboratories. Those are used to calibrate the coordinate measuring machine. Thus the machine itself is a reference standard which can be used to measure workpieces traceably.*

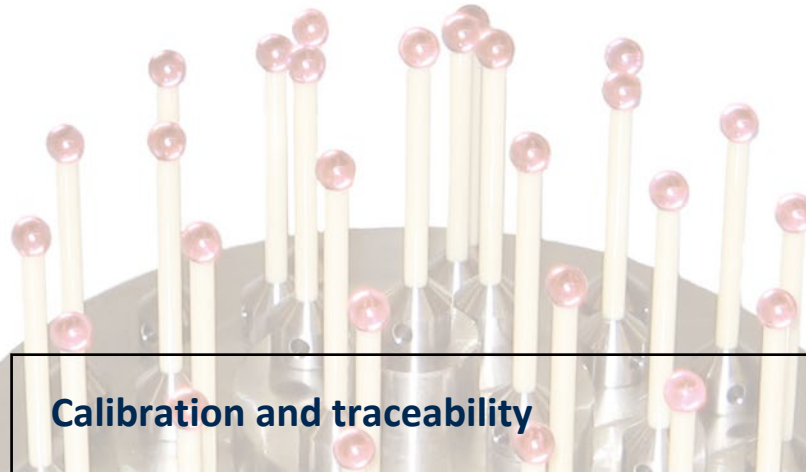

## Calibration and traceability

Standardized specifications and a certified calibration allow for the objective comparison of instrument performance and ensure traceable measurements. The most important characteristics of a coordinate measuring machine are the maximum permissible error of length measurements (MPE E) and the maximum permissible probing error (MPE P). During the inspection of a coordinate measuring machine, as part of the acceptance test for the customer or during device maintenance, the measurement deviations from these tests are compared to the calibrated values of the standards, which are determined in accordance with DIN EN ISO 10360 and the VDI/VDE 2617 guideline. For a calibration, the measurement uncertainty must also be provided. In order to be sure that the test is performed in accordance with the standard, the manufacturer or the calibration lab should be in possession of a valid certificate from a national accreditation body (DAkkS for Germany). The use of calibrated standards allows traceability to international standards.

## Traceability of coordinate measuring machines compliant with IATF 16949

The first edition of the ISO/TS 16949 standard (predecessor of the IATF 16949) at the end of the 1990s led to new requirements for the traceability of the metrology equipment used. Coordinate measuring machines are particularly suitable for monitoring and calibrating this equipment. This led to the demand for an accredited calibration for coordinate measuring machines, especially in the automotive industry.

In 2003, the DKD guideline DKD-R 4-3 sheet 18.1 (DKD – German Calibration Service) was published; first accreditations of laboratories for tactile coordinate measuring machines followed. In 2004, Werth Messtechnik was accredited by the DKD as the first German laboratory for the calibration of optical and multisensor

coordinate measuring machines. The procedures described in VDI 2617 Part 6 for coordinate measuring machines with optical probing were developed with the substantial cooperation of Werth Messtechnik.

Since then, the laboratory has been continuously active, and the methods mentioned have been further developed and expanded. In 2011 the Werth DAkkS laboratory (DAkkS – German Accreditation Body) was the first and, until 2018, the only facility of its kind to be accredited for the calibration of coordinate measuring machines with computed tomography sensors according to VDI/VDE 2617 Part 13. In 2019, the conversion to the current version of ISO 17025:2017 took place within the framework of a re-accreditation.



*Dieter Lehr, since August 2002 at Werth Messtechnik*

## Our field service

### What are you doing, Mr. Lehr?

I remove a transport lock. These locks are used to protect the sensitive guideways of the machine axes. They could be damaged, for example, by truck transport in bad road conditions, since considerable weight is moved. They must be secured and unlocked in the correct order so that no harmful forces act on the device.

### Tell us about your career.

As a precision mechanic in the microfilm industry, I realized in 1996 that microfilm is hardly used anymore. I finished a training program as a technician in the evening school, which was a hard way, and then started at Werth. At that time, we had to give the customers, which were mostly just familiar with hand-held gauges, confidence in using the CNC-controlled multisensor coordinate measuring machines. Due to my many years of experience, I now have a wealth of experience and I am entrusted with demanding tasks, such as repairs and maintenance work on our machines and sensors such as the patented Werth Fiber Probe®.

### What do you enjoy most at work?

I explain to the customer what they need to be aware of when dealing with our multisensor systems, and experienced customers tell me in return how they measure. Some customers use the machines for decades, so over the years maintenance and updates are carried out time and again to keep the machines up to date. This usually results in a very good and almost friendship relation with the customers over the years. In addition, very interesting is the fact that you get insight into different worlds: automotive industry, plastic injection molding, medical or stamping technology. I see what is being produced, and I ask what they do with it or I see what research institutes are working on.

## And what are you doing, Mr. Richter?

The axes of some machines move on air bearings, and these float on air cushions with a few microns in height, the so-called flying altitude. If the air filter fails, dust or other particles from the air supply can stop the air flow in the bearing. Therefore they are checked during the maintenance of the machine. With an air flow meter, I check how much air flows through the bearing and with a dial gauge, I check the altitude. Thus, problems in the bearing and thus additional measurement uncertainties can be excluded early.

## Did you start your career in metrology?

Initially, I worked in control technology and in quantity measurement and then became interested in metrology. Through Werth I saw a possibility of professional development in this field. The field service appealed to me, because I can bring in my experience and skills well here.

## What are the highlights of your work?

In field service, I get to know the entire range of manufacturing industry and it combines many job descriptions in one: mechanic, electrician, IT specialist and sometimes psychologist. The work ranges from commissioning, calibration, maintenance, relocation and repair. You can see many different machine types and different applications. At universities or technical colleges, the  $\mu$  is often split, and in manufacturing-integrated solutions, throughput must be right. I find repairs particularly exciting, because with the error analysis one can use his knowledge comprehensively and very often within a short time a result is achieved. The customer is happy and can continue working and I'm glad to have helped quickly.



**Uwe Richter**, since October 2002 at Werth Messtechnik

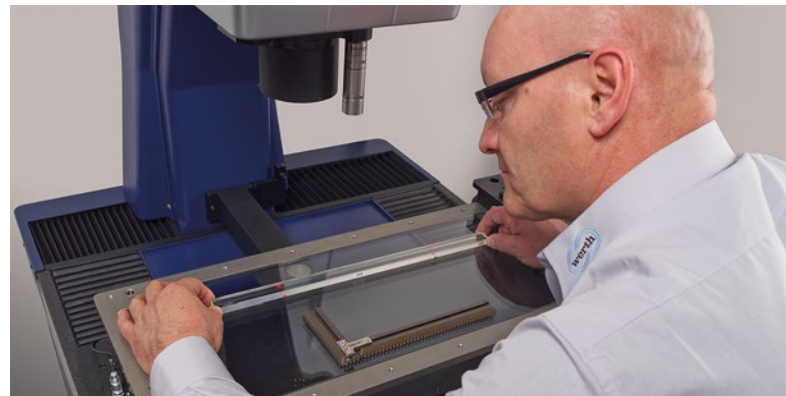

**Manfred Lindert**, since February 2011 at Werth Messtechnik

## And Mr. Lindert, what are you doing right now?

I check compliance with the specification given for the X-axis. For this, the distances and widths of the line marks whose distance is calibrated are measured on the glass scale. Deviations from the calibration value must not exceed the specified limit value of the maximum permissible error for length measuring. For checking the corresponding 2D and 3D deviations, calibrated standards are measured in one plane or even in space.

## What led you to us?

At Werth I applied because I was looking for a technically challenging task that also involves dealing with people. In the field service, I get to know new people and face always other situations. I could not go to the same office every day and always do the same thing.

## And what makes your work so interesting?

The work is varied and demanding. I am always impressed, what is possible, for example, with the image processing sensor. You are constantly in front of something new and you have to deal with it, and it is always nice to use experience as an asset.

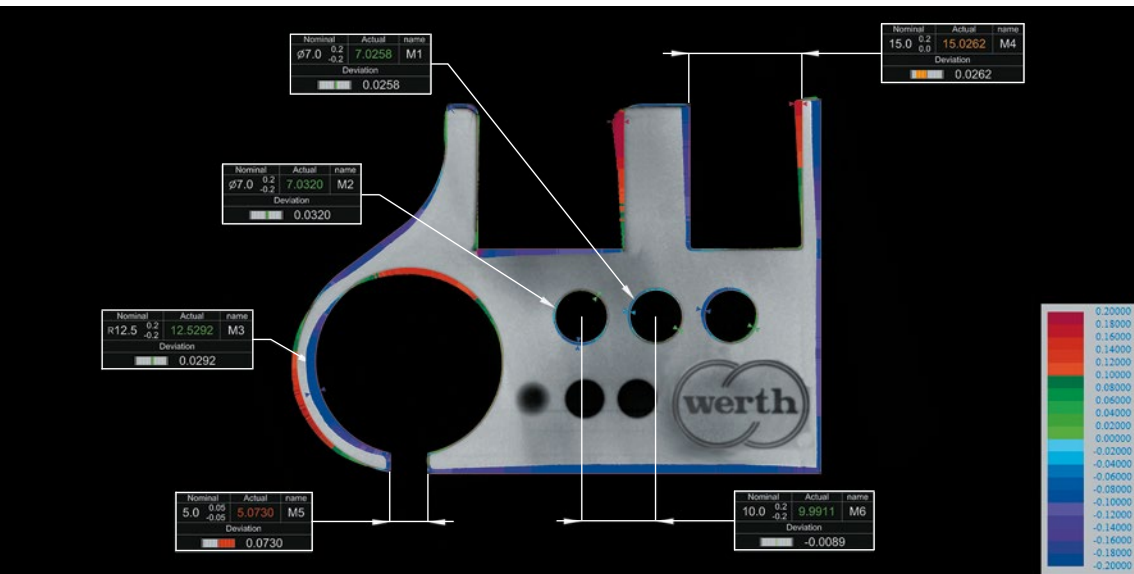

The superposition of CAD model and volume cross section with display of geometrical characteristics allows non-destructive testing and measurement in parallel.

## WinWerth® 9.43 – New functions for rapid measuring and editing

To make it easier to create and edit measurement sequences, the new version of WinWerth® has a wastebasket function. The procedure is based on familiar Microsoft Windows features. Objects that are deleted during an editing session are saved and can be restored at any time. Restored objects are inserted back into the feature tree at their original position and are highlighted. With the expanded scope of commands for TeachEdit processing, parameterized programs can also be edited directly in the feature tree. Manually created DMIS formatting, such as paragraphs, indentations, comment lines, etc., remains intact. Subroutines can also be edited and then saved in DMIS format.

In Version 9.43, several calculation operations have been sped up significantly. This applies to the computation of large point clouds, partial contours, and actual-to-actual comparisons, which often come up when using the Chromatic Focus Line and computed tomography sensors. It takes less time to open measurement sequences, and 3D graphic views can be saved faster in the DMIS program.

For WinWerth® Profile Comparison, where a 2D CAD model is superimposed on a video image, geometrical characteristics such as diameters and distances can be displayed using the ISO 16792 standard. In addition to live, raster, and video images from the image processing

sensor, such as are found on the Werth QuickInspect and QuickInspect MT, the function is also available for the Chromatic Focus Line and the Volume Section Sensor in computed tomography.

As of version 9.43, mirroring of measurement sequences is now available for those that use 3D CAD models as well. For example, analysis programs of large point clouds with patch selection on the CAD model can now be mirrored.

The new WinWerth® Scout user interface allows for fast, simple evaluation of measurement results with a graphic display. This capability is also available for networks of computed tomography and multisensor coordinate measuring machines, as well as offline workstations (see p. 6–7). WinWerth® TomoAssist provides optimal measurement parameters for computed tomography measurements in just a few steps, even without expert knowledge (see p. 8–9). The functional scope of WinWerth® VolumeCheck (see p. 17) and WinWerth® FormCorrect (see p. 27) has been expanded.

The new version of WinWerth®, with these functions and more, is available as 9.43 for Windows 10 and as 8.43 for Windows 7. For detailed information, please see the version information for WinWerth® 9.43.

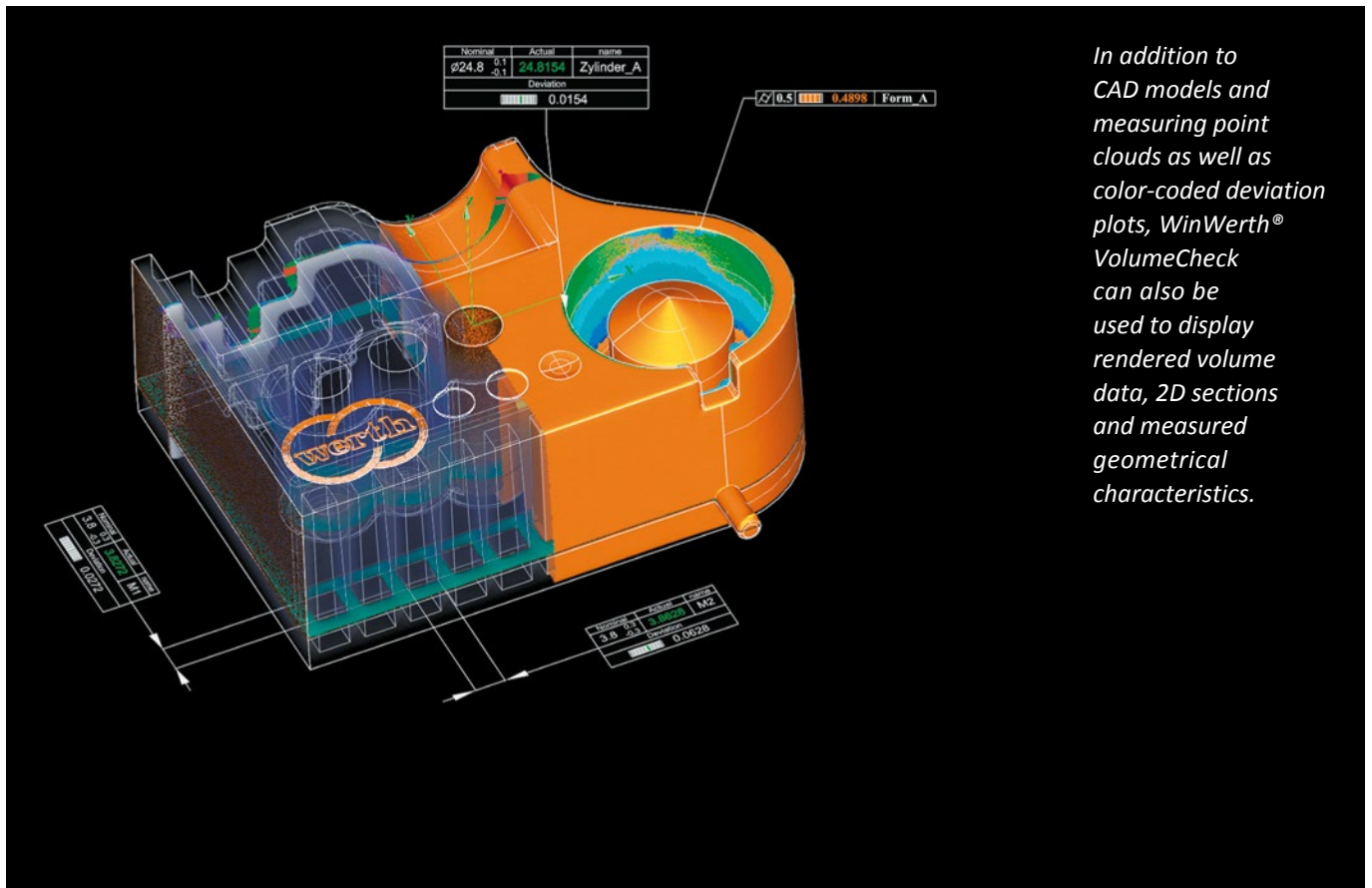

*In addition to CAD models and measuring point clouds as well as color-coded deviation plots, WinWerth® VolumeCheck can also be used to display rendered volume data, 2D sections and measured geometrical characteristics.*

## Greater transparency in the voxel volume

CAD models, measurement point clouds, and volume data can be displayed one at a time or superimposed three-dimensionally in the same coordinate system with the 3D module of WinWerth® measurement software, so they can be analyzed from all sides. The measured geometric characteristics, lines, angles, or form and position tolerances, are also displayed. In WinWerth® 9.43, the display can be clipped using arbitrarily definable clipping planes. Outside of the clipping planes, the model and measured data are hidden. The entire workpiece can be eroded, plane by plane, and visually checked for voids, for example. Clipping planes can be used to check the material, internal geometry, and individual components of multiple-material workpieces. Both clipping planes and sectional planes for depicting and inspecting 2D cross sections can be moved and rotated in three dimensions, using the mouse, directly in the 3D graphic display. Mouse clicks on the voxel volume now generate 3D surface points for alignment, which is

now possible even without a prior calculation of the measurement point cloud.

Using the histogram function, the transparency can be varied for selected greyscale ranges and the greyscale value can be depicted on a color scale. By varying the transfer curve at any desired partial intervals, greyscale values and color regions can be spread to increase contrast. The transfer curve can now be defined once for a sample part and then saved for series measurements on identical workpieces. This ensures optimal representation of each voxel volume for rapid inspection.

The conversion of the voxel volume and visualization under poor contrast conditions have also been improved. The volume can now be converted more quickly, and the converted file uses less storage space. With the new functions, comprehensive inspection with WinWerth® VolumeCheck is now even faster and easier.



## Summertime family fun at Werth

Since its relaunch as an independent company in 1993, the start of summer has been celebrated at Werth every June. On the occasion of the 25th anniversary in 2018, all employees and their families were invited to the summer festival. The invitation drew 500 guests who spent a lovely time together.

There were bobby-cars, balance games, circus stations, and a bouncy castle for the amusement of the littlest guests. For the adults, a Segway course (helmet required!) was laid out, and competitions were held in darts and table soccer. After coffee, cake, and many interesting discussions, memories of the old days were stirred by the live performance of Pit Grün & Band, who first livened the mood at the Werth summer festival 20 years ago. The sounds of international artists from Bruce Springsteen to Joe Cocker filled the air. As is the tradition at the Werth summer festival and Christmas parties,

*Family summer festival 2018 at the Werth company premises*

anniversaries of 40, 25, and 10 years with the company were celebrated. Of the original 35 or so Werth employees, many are enjoying a well-earned retirement, but 20 are still with the company.

On-site cooking started at 6:30 PM. At the Bella Italia pasta station, the grill, and the wok, the order of the day was "All you can eat. Of course, burgers, fries, and all the fixings could not be left out, including an ice-cream truck. Early in the evening, the performance of the Werth band, with the telling name "Out of Tolerance," was greeted with enthusiasm. Afterward, DJ Mo brought the right sound and the dance floor was filled with hard beats until the early morning hours. The thanks of all participants for the perfect part planning over the past two decades go to the management assistant Marion Obert.

*Out of Tolerance:  
"Everybody Needs  
Somebody"*





*Hiking with a view of the Matterhorn*



## One four-thousand meter summit each for everyone

Bright sunshine and snow-capped mountains: an event in surroundings like these is a perfect retreat from everyday stress, making space for a clear head, new ideas, and forging close bonds.

As it has several times in the past, Werth Messtechnik held a motivational retreat in the mountains again in 2018. Around 40 colleagues, including some from the USA and China, accepted the invitation to the Valais Alps. After arriving in Zermatt by bus, a special train climbed the cog railway to the hotel on the top of the 3,135-meter Gornergrat mountain. The spectacular landscape, with a panoramic view of the surrounding 38 four-thousand meter peaks, provided the perfect backdrop for conquering challenges as a team.

After two days of acclimatization with easy hikes, on the third day the path led “onward and upward.” The climb up to Hörnlihütte mountain hut (3,260 meters) brought the group closer to the Matterhorn than ever before. The next day, 18 people formed four rope teams to climb, crossing the glacier, on the Breithorn (4,164 meters) and impressed even the alpine guides with their extraordinary team spirit. For those with less training, a visit to the ice palace in the Theodul glacier was scheduled for the same time. Together again at the mountain hut, everyone exchanged their experiences while enjoying cheese fondue and other delicacies. A night-time tour through the Stellarium observatory on Gornergrat, with an explanation of the astronomical devices, was especially interesting for the Werth metrologists.

*A snack at the hut by the green mountainside*



*Werth rope teams on the 4,164-meter Breithorn*



*The Werth band „Out of Tolerance“ at 3,100 meters*

Werth multisensor machine  
used for electromobility and  
transmission parts at VW

Highly accurate  
quality assurance



The increasing emergence of electromobility has led to an increased variety of measurement tasks in the pilot production center of the VW plant in Kassel. For two years now, measurement technicians have used a VideoCheck® DZ HA 3D coordinate measuring machine from Werth to handle these requirements as efficiently as possible.

*With the Werth Fiber Probe® even small parts can be measured on the large measuring machine, due to the low probing force without fixed clamping.*

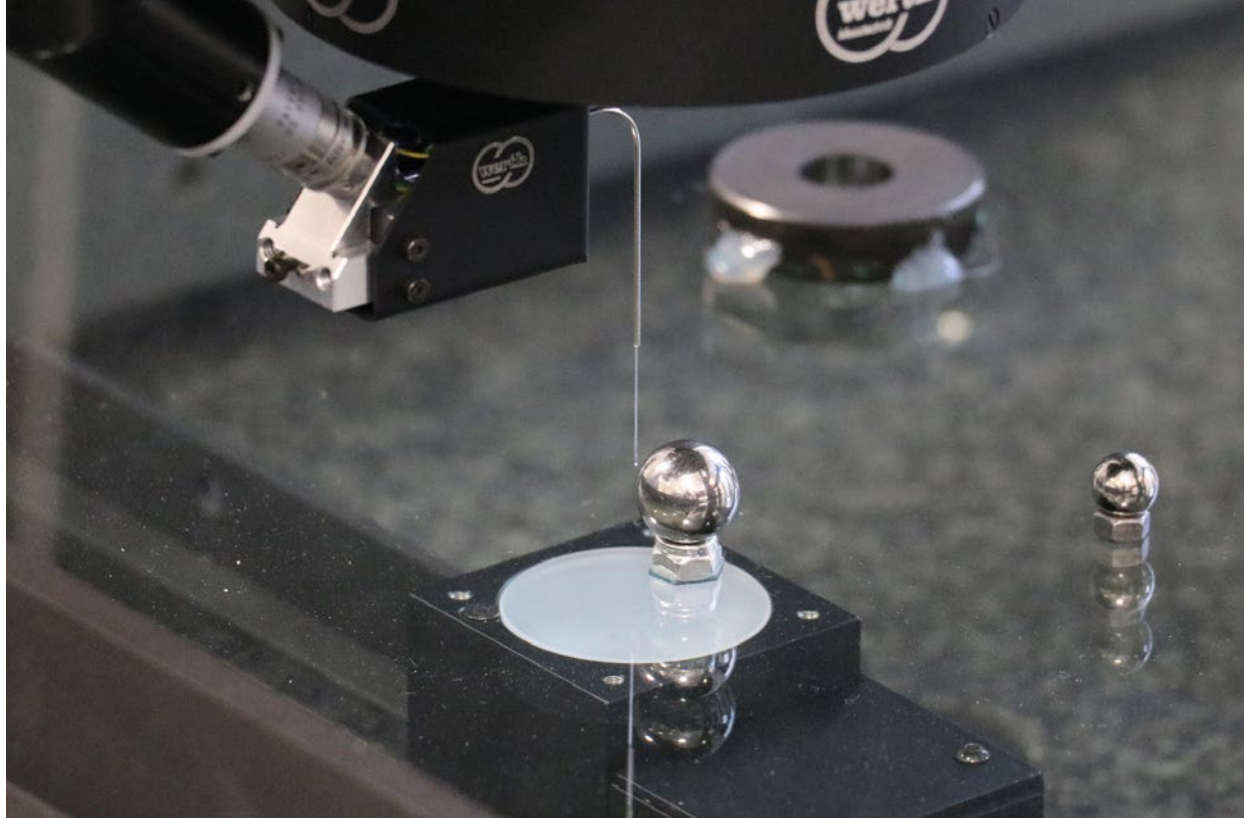

The core business of the Volkswagen plant in Kassel, Germany, which has around 16,000 employees, is transmission manufacturing. About one-third of the workforce is engaged in this field and ensures that over 15,000 transmissions per day, or about 3.7 million per year, in 16 different variants, are shipped throughout the company. Because this location is a lead plant for the transmission business segment, Volkswagen has a high level of development expertise here, along with a pilot production center where prototypes of newly developed transmissions are built.

The pilot production center is part of the transmission business segment, where production processes are devised for transmissions and for hybrid and electric drives. Metrology planner Ulrich Schneider is a member of this department. His area of responsibility includes all metrological equipment, needed for manufacturing transmissions for combustion and electric engines, from plug gages to coordinate measuring machines.

As automotive drive technology changes, the requirements for metrological equipment in the pilot production center have risen in recent years, as Schneider reports: "As E-mobility takes on an increasing role, we have had to expand our equipment so that our pilot production measurement lab stays up to date."

The lab falls within the purview of Normen Hitsch, who is the foreman responsible for the pilot production measurement lab. With his team of 15 employees, he takes on measurement tasks primarily for the development department, but also for production, quality assurance, and planning. "We mostly measure transmission components and elements for electric motors

at this time. These workpieces vary greatly, from ball bearing components in the millimeter range to axles, shafts, rotor and stator punchings, and entire transmission housings."

This means that employees and equipment need a great deal of flexibility. To achieve this, VW is expanding the existing laboratory, adding a second lab, and investing in a large 3D multisensor coordinate measuring machine to add to the existing thirteen different measuring machines.

A project team consisting of Schneider as the planner, the measurement technicians on Hitsch's team, and a project manager for the structural building components, has been working on the appropriate selection since 2013. "Our specification defines the three main requirements: high precision, a large measuring volume, and the ability to use a variety of sensor systems," explains Schneider. "The details cover existing measurement tasks as well as future requirements to be met."

### **Multisensor measuring technology has been proven in practice many times at VW**

The project team used that specification to request bids from measuring machine manufacturers around the world. This was followed by extensive analyses of the quotations, on-site tests with challenging workpieces, and finally a decision. "With this measuring machine from Werth Messtechnik in Giessen, Germany, we had filtered out the right one for us from the short list of six providers," says Hitsch confidently. "The VideoCheck® DZ HA 3D coordinate measuring machine that we installed in 2015 has proven itself many times over."

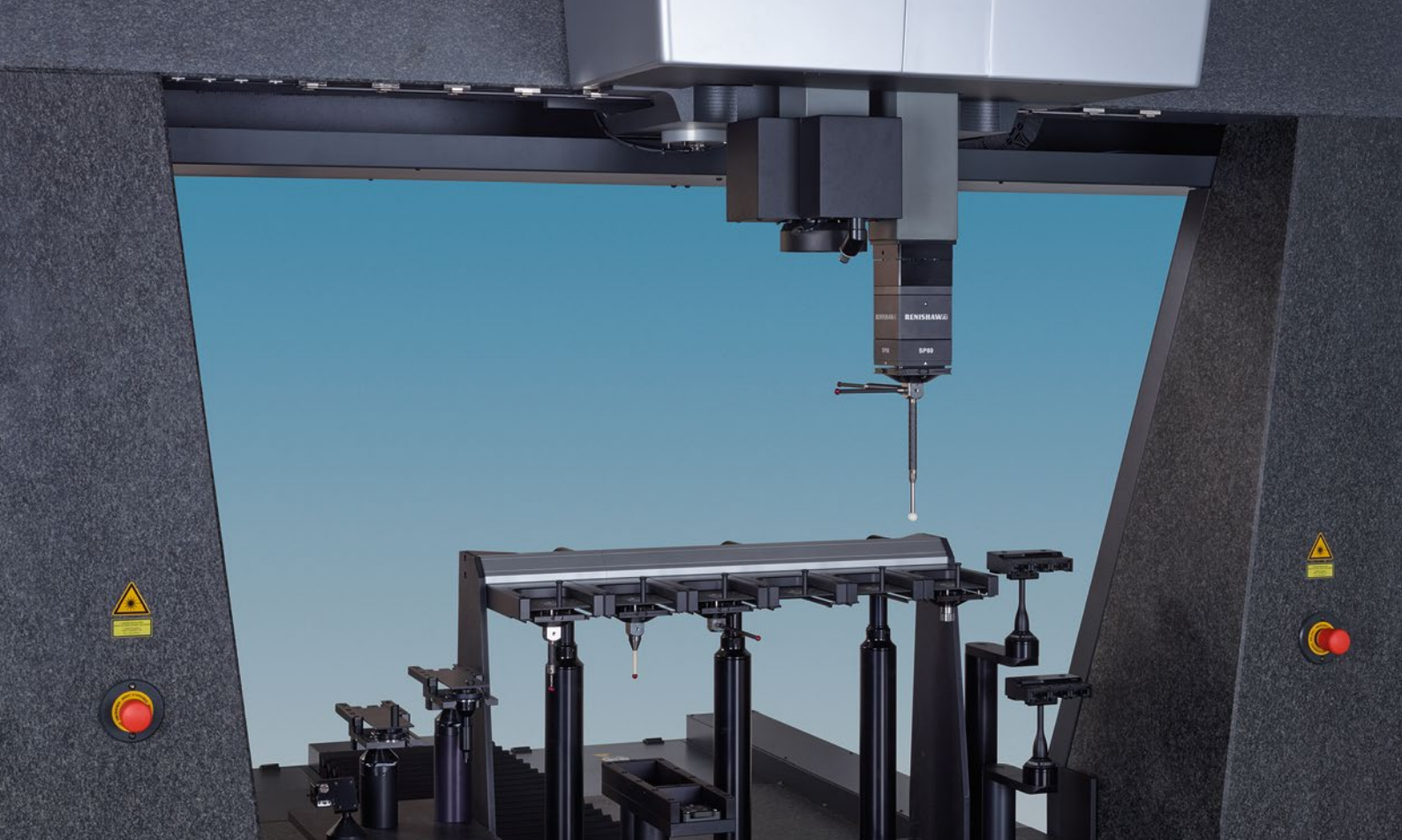

With a specified maximum permissible error MPE E of  $(0.5 + L/600) \mu\text{m}$ , it is highly accurate. Its measuring volume of 1130 mm x 2000 mm x 800 mm and various optical and tactile sensors, which can be used on two independent Z-axes, cover a greater range of applications than ever before. It is also possible to retrofit a third arm, if needed, in order to incorporate even more measurement options with additional sensors.

Currently four employees run the machine in doubles in a shift operation. Quality inspector Hans-Werner Scholz reports: "Traditional measurement, like we were familiar with on turned and machined parts, has changed with the new components for electromobility. We developed new measurement strategies in internal workshops as to how we can best capture the dimensions of stator and rotor packets, for example."

Scholz and his three colleagues Markus Hartmann, Peter Rubik, and Jens Kaul – all quality inspectors certified by AUKOM (German apprenticeship program for metrologists) – appreciate the multisensor systems of the VideoCheck® machine. They apply optical and tactile sensors as needed. They use the traditional image processing optical sensor, for example, to measure stator and rotor punchings and other flat workpieces, such as sealing rings, clutch plates, and other electronic components with high accuracy and without contact, using transmitted and incident light.

Another optical sensor that is available is the Werth Laser Probe (WLP), which they use to scan the work-

piece surface. This can be used to measure workpiece flatness very quickly. "We can capture the waviness of steel plates for clutch modules," explains Scholz, "and we are much faster than if we were to use tactile sensors." The WLP runs at a higher speed and greater point density than the tactile alternatives, with nearly the same accuracy.

### **Micro-stylus for ball bearing features that are difficult to access**

The measurement technicians often use the patented Werth Fiber Probe® (WFP) as well, which is considered a tactile-optical sensor. It consists of a glass fiber that can have a probe sphere with a diameter as small as 20  $\mu\text{m}$  mounted on its end. Unlike a tactile measurement, the deflection is not transmitted to the machine electronics via the stylus. Instead, the position of the probe sphere is captured optically by the image processing sensor itself.

This makes the fiber probe extremely accurate as well as easy to use. The user can track the position of the probe sphere on the monitor, so it can easily be positioned at the desired measurement point. The team uses the WFP® in the pilot production laboratory to measure steel balls from a supplier's ball bearing. Quality inspector Scholz explains: "A single ball bearing is very difficult to clamp in a fixture. This is not even necessary for a fiber probe measurement, as it is essentially a non-contact procedure, and the ball will not roll away."

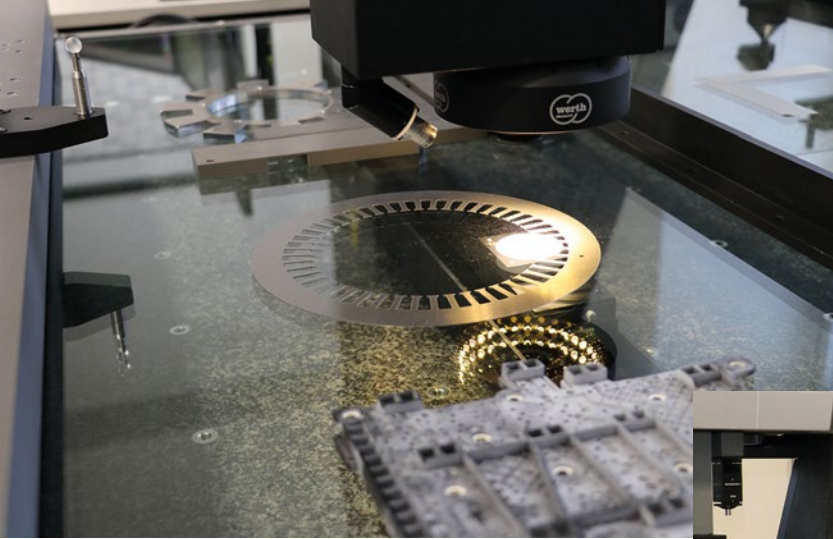

The image processing sensor is used to measure stator punchings, rotor punchings, and contact plates, among other products.



The project group that was intensively involved in the selection of the 3D multisensor coordinate measuring machine includes (from left) Normen Hitsch, Hans-Werner Scholz, Ulrich Schneider, Peter Rubik, Jens Kaul, and Markus Hartmann (right). With them is Werth Sales Manager Detlef Ferger (second from right), celebrating the successful project.

The large machine is also used to measure very small workpieces. Due to its extremely delicate structure, the fiber probe is used for many other workpieces that cannot be measured with a purely tactile sensor due to holes that are too small and too deep, or small slots on engine assemblies.

The patented Werth Contour Probe (WCP) for measuring profiles and roughness also functions on a tactile-optical basis. "Because it actually contacts the workpiece with its tip, we do not use it for soft materials such as rubber, but rather for roughness measurements on non-machined surfaces such as forgings," says Scholz.

### Scanning probe SP80 can reach deeply buried measurement points in a workpiece

The optical sensors are complemented by two conventional tactile measurement systems. The SP80 scanning probe can reach measurement points that are deeply buried in a workpiece, because it can mount very long stylus inserts that are ideal for plunging into a transmission housing, for example, and taking measurements there. With the SP25, the Werth VideoCheck® also has a stylus that can rotate and tilt at 7.5° intervals and can measure positions that are difficult to access, such as undercuts and lateral holes.

For foreman Normen Hitsch, the newest 3D coordinate measuring machine not only offers future potential,

but in his view, the investment has already paid off with the improvements that have been achieved. "For some measurement tasks, such as the ball bearings, we never had a solution. Other measurements were possible, but they were only manual and therefore not very reproducible. Large workpieces did not fit on our previous coordinate measuring machine. The measured objects often had to be destroyed in order to be able to measure the interesting areas. These problems are now solved with the new 3D multisensor measuring machine, and we are well equipped for future measurement tasks as well."

Ulrich Schneider adds: "Multisensor systems qualify our machine not only for a variety of different components, but also for complex measurement tasks. For the encoder wheel of an electric motor, for example, we use several sensors in parallel: the laser as a surface sensor for flatness, the image processing sensor for the wings mounted on the workpiece, and the fiber probe for a very small, narrow groove."

The metrology planner points out that the measurement lab team has a very close working relationship with Werth. Discussions are held at regular intervals to promote future topics in the interest of both parties. "This is another very positive aspect of working together with Werth."

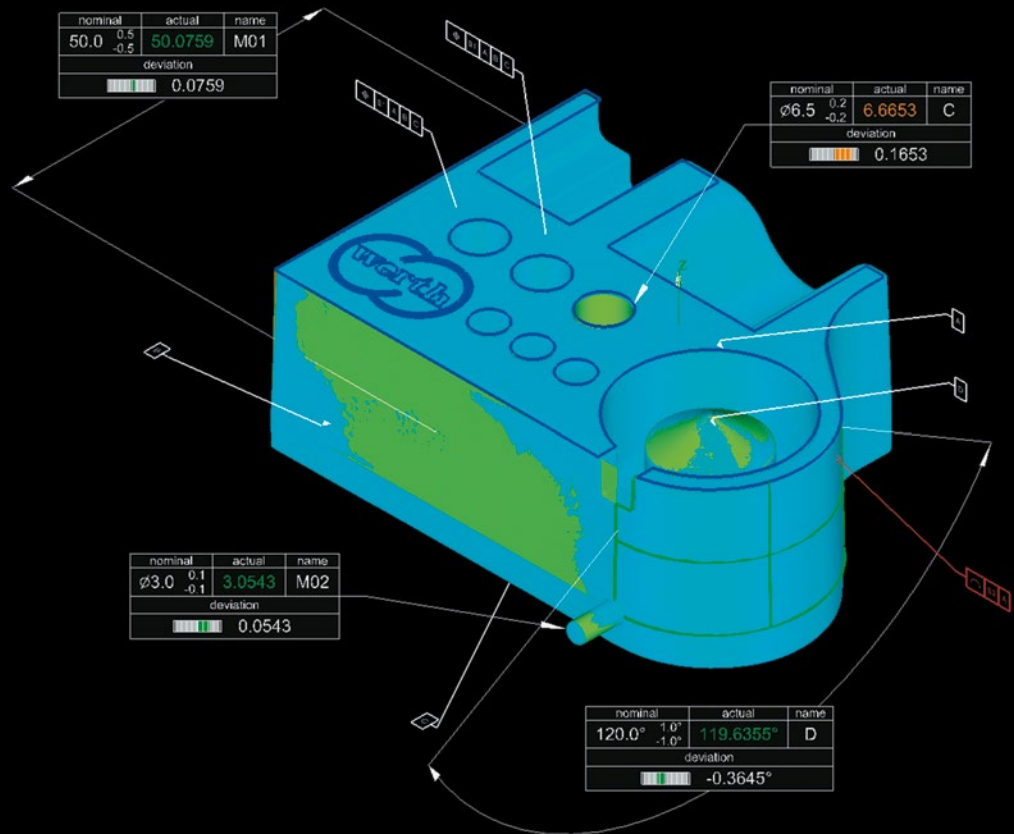

*The geometric elements of the PLATO universal training object are matched to the typical application areas of different sensors.*

## PLATO – Introduction to measurement software with tutorials

Werth Messtechnik has launched a new training concept based on the universal training object PLATO (Personal Learning And Training Object). Its parameters are based on typical applications and measurement ranges for the image processing sensor, various optical distance sensors, conventional tactile sensors, the patented Werth Fiber Probe®, and computed tomography. With PLATO, tutorials enable beginners to get started quickly with WinWerth® measurement software for all types of machines and sensors. Tutorials for conventional tactile sensors and computed tomography are now available. More of them will follow soon.

Corrected  
mold  
CAD model  
Original  
mold  
CAD model  
Original  
workpiece  
CAD model

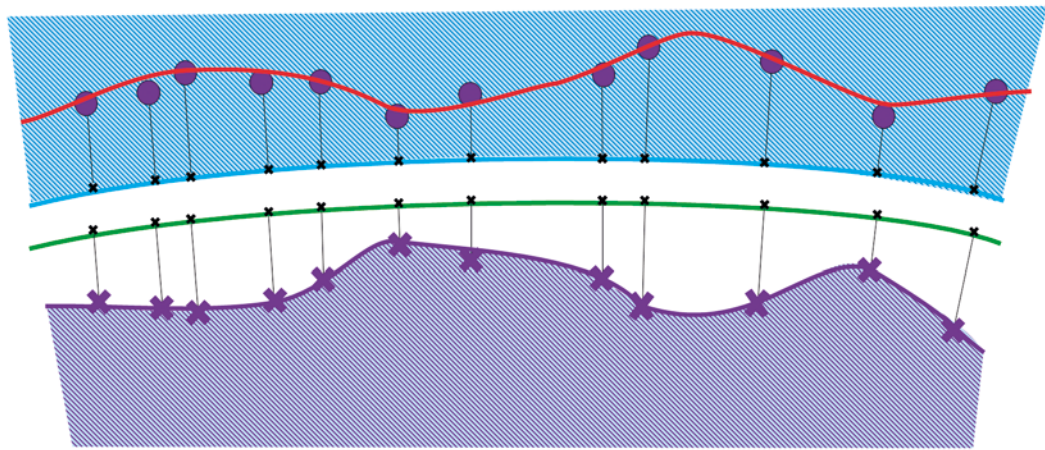

- ✘ Measurement point
- \* Perpendicularly projected point on CAD patch
- Mirrored measurement point

*Correction of the mold CAD model with WinWerth® FormCorrect: The measured deviations of the workpiece from the workpiece CAD model are mirrored on the latter, and used to correct the corresponding shape in the mold CAD model (green for the workpiece model and blue for the mold model).*

## Greater flexibility for mold correction

In plastic injection molding and 3D printing, aspects of the process cause systematic deviations in geometry. The FormCorrect software module is an integral part of the WinWerth® software package and enables product optimization with largely automated correction of the CAD model. By optimizing the process, typically in just one loop, development costs can be reduced significantly.

The functional scope of this feature has been expanded to provide even greater flexibility. Display options have been expanded for greater operator convenience. To check the parameter selection, the relevant measurement points and the original and expected remaining deviations can be shown prior to applying the correction. Because correct alignment of the measurement point cloud to the CAD model is a prerequisite for good correction results, the deviation element can now also be shown and checked. In addition to measurement points, additional display options can be turned on and off. The displayed cylinders of the point selection allow the resolution of the correction to be checked. The arrows within the cylinder show the deviation for each point and can be hidden to make the display easier to see.

In the expanded version of FormCorrect, elements that are not relevant to the function, such as texts and ejector marks, can be excluded from the correction.

When calculating the deviation element, it is now possible to take into consideration several measurements, so that even with wide variation in the process, an efficient correction is possible with low residual deviations from the CAD model. The correction can now be performed for all desired patches after the parameters have been defined. This separation of the two steps provides a better overview of the correction procedure.

In addition to the workpiece CAD model, the correction can also be performed directly in the mold CAD model. In this case as well, the measured deviations of the workpiece from the workpiece model are mirrored on the latter to calculate the deviation element, as a corresponding surface exists in both models. This is the surface at which the workpiece and the mold make contact during injection molding. The only difference between the correction to the workpiece model and that of the mold model is whether material is to be removed or added. For example, if the workpiece is too thick, then material must be removed from the workpiece, and material added to the mold.

With post-processing of measurement data directly in the measurement software, WinWerth® FormCorrect is taking root as an interface for quality assurance in the plastic injection molding process.

## Werth subsidiaries introduce themselves – Werth Messtechnik France SARL

In 1995 Werth Messtechnik France SARL was founded together with Mr. Bruno Vetticoz. Mr. Vetticoz had already been a sales manager for Werth products at the former Werth dealer for several years. As a result, he was very familiar with the technology and the corresponding processes and was able to continue the business seamlessly.

Today, the company has eight employees who look after the Werth business in France and in French-speaking Switzerland. Several hundred customers are now happy to rely on Werth France for advice and services such as commissioning, maintenance and application programming. Many devices are used in the automotive industry, medical technology or aerospace industry.

*Company outing to Berlin on the occasion of the company's 20th anniversary in 2015*



*The company headquarters and demonstration center are located south of Paris, near Orly Airport.*

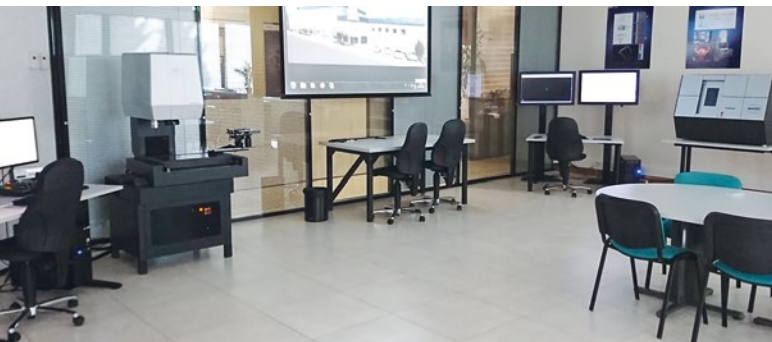

**Bruno Vetticoz**, Managing Director, with Alexandre Morvan, Application and Training, at the customer

“For more than 20 years we have been representing the products of Werth Messtechnik GmbH here in France and French-speaking Switzerland. It is a pleasure to be able to offer our customers innovative solutions and support them in integrating the measuring instruments into their industrial processes.”



**Anne Marie Gérard**, for ten years the “good soul of the company” and Management Assistant

“I take care of all administrative matters: accounting, finance, customs formalities, relations with social and educational institutions, trade shows, follow-up of customer and supplier orders, purchasing and shipping, invoicing, inventory, etc. I get in touch with all players in the metrology industry: customers, suppliers, management, technicians, the plant in Giessen and our sales representatives.”







**Alexandre Morvan**, Application and Service engineer at Werth France for seven years, prepares a ScopeCheck® S for a trade show.

“My task is to develop customer-specific solutions and communicate their technical advantages in order to improve quality assurance and thus the customer’s competitiveness. I like that no two days are alike. I come into contact with different people and industries, so my work is interesting and very varied. Recently I made it possible for a customer to solve his measuring tasks by a combination of an image processing sensor, the Werth Laser Probe and the Werth Fiber Probe®. No other competitor could offer this, and the customer is enthusiastic.”

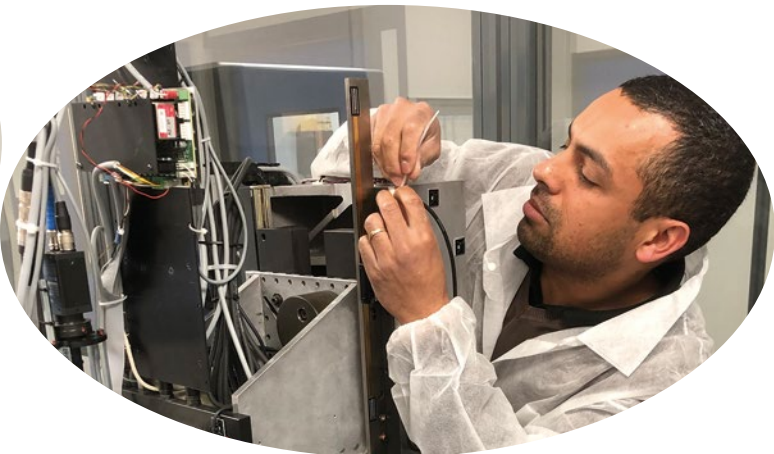

“Since February 2008, I have mainly been looking after customers from the aviation industry, such as Airbus, Lisi, Safran, Thales and many others. I like to exchange ideas with them, get to know their tasks and support them with our technology to solve their measuring tasks.”

**Henry Fabre**, Sales Representative at Werth France for 11 years

“After studying measurement technology, I joined Werth in 2012 as an application engineer. With device demonstrations, test measurements and training courses for various customers as well as at trade fairs, I got to know the world of measurement technology from all sides. I enjoy analyzing measurement tasks and then offering our customers the best solution. To further develop my skills, I also got qualified for technical service. My many years of experience enable us to provide optimum support for our equipment technology in all respects.”



**Christophe Hayoz**, Sales Representative at Werth France for one year now

“I love my job because in no training class you can learn all the things we need in everyday life. I’ve been working at Werth for 11 years now, learning every day.”

**Cedric Corvisy**, Service Engineer at Werth France for 11 years, at a VideoCheck® S



## Highly accurate, rapid measurement in any orientation

The Werth Chromatic Focus Line sensor (CFL) combines high accuracy with the rapid capture of about a million measurement points in three seconds. The CFL can be used to measure diffusely reflective, mirror-finish, and transparent workpieces. When combined with a rotary axis, the sensor allows the user also to fully digitize and measure cylindrical workpieces. Typical areas of application include tool production and medical technology.

Rotary/tilt axes allow individual geometric elements to be optimally aligned with the sensors in two axis directions. With a rotary/tilt axis, optical distance sensors can also measure vertical surfaces or undercuts. Different partial segments can also be measured and analyzed in the same coordinate system. Error-prone stitching is not necessary, as all components of the coordinate measuring machine are precisely calibrated to each other. This combination is now available for CFL as well, and allows complex structures to be measured.

Application examples include molds for producing contact lenses, turbine blades, die stamps, EDM tools, or forming tools for stamped parts.

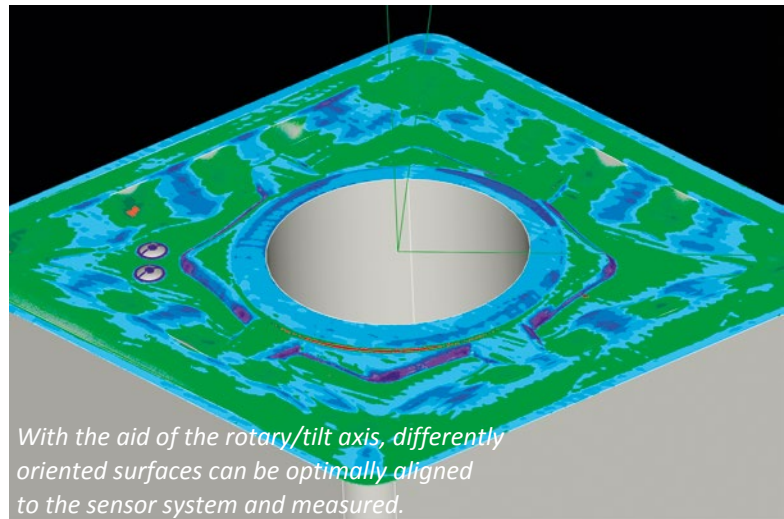

*With the aid of the rotary/tilt axis, differently oriented surfaces can be optimally aligned to the sensor system and measured.*

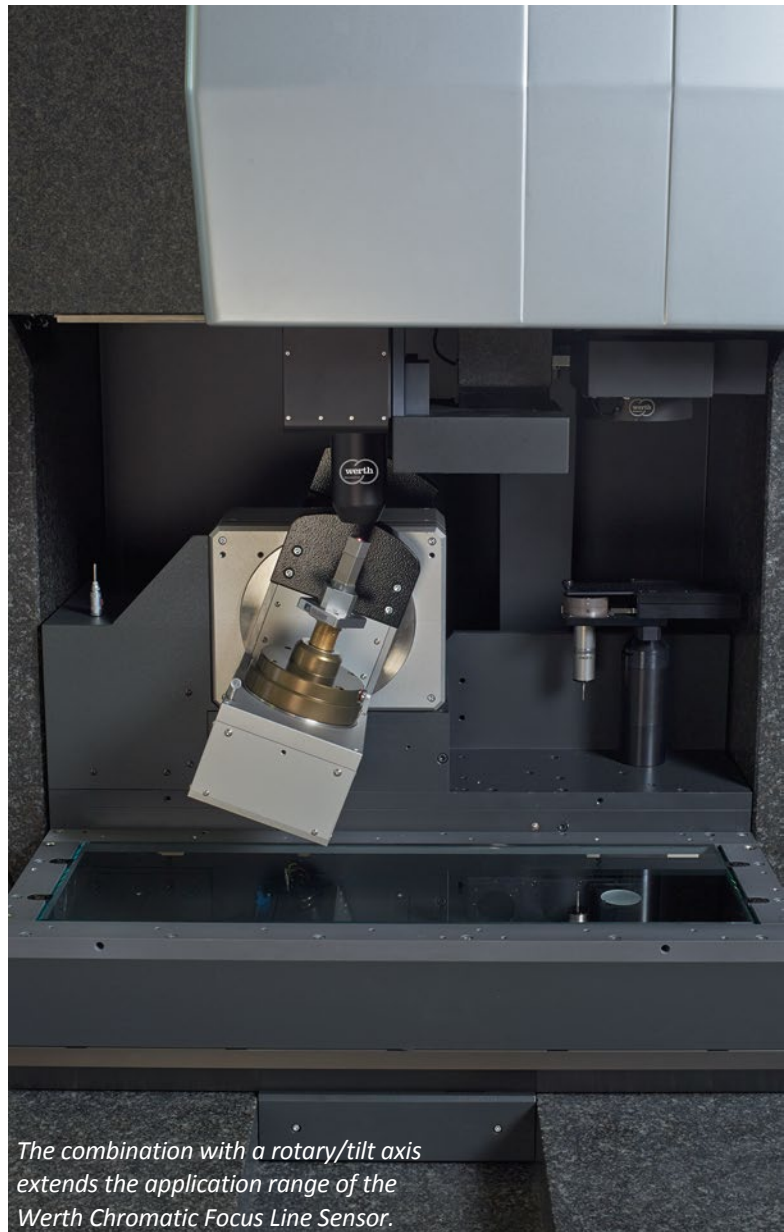

*The combination with a rotary/tilt axis extends the application range of the Werth Chromatic Focus Line Sensor.*

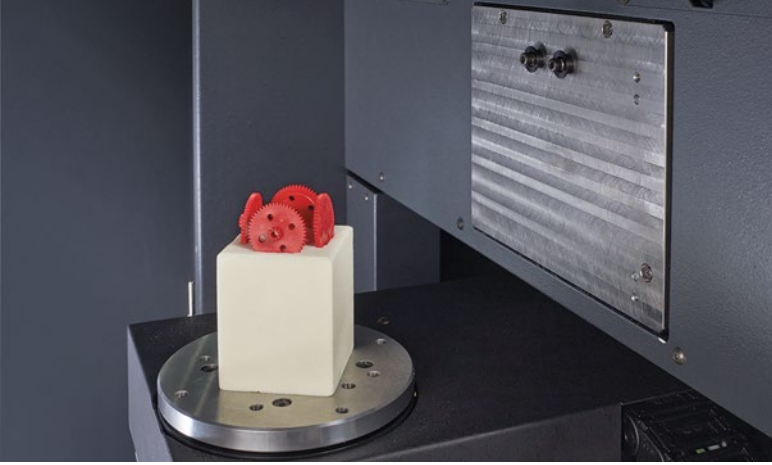

Using the CT data, gear evaluation conforming to international standards is possible. In addition, the deviations from the CAD model can be determined for the entire surface by tomography and internal geometries or voids can be measured.

With plastic gears, often all teeth have to be measured due to the manufacturing process. Computed tomography allows the entire workpiece to be captured in a single measuring process, thus achieving an enormous time advantage.

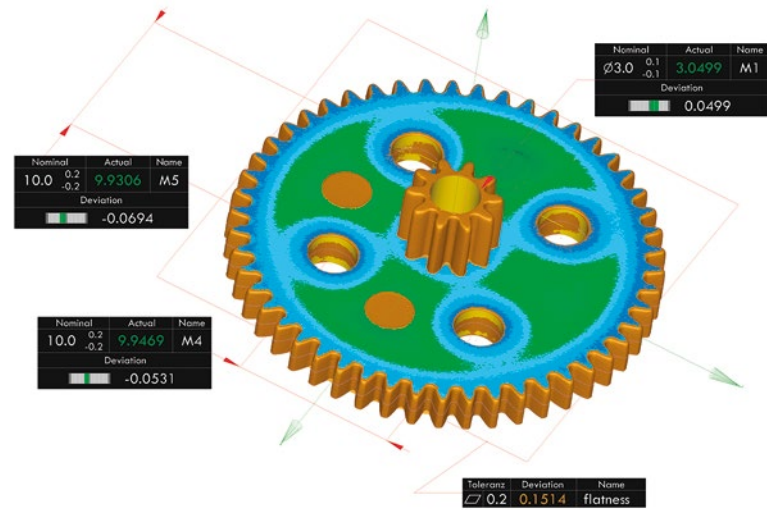

## Complete measurement of plastic gears

Gears are used primarily for transmitting torques with zero slippage and are used in nearly every technical device. Examples can be found in electric motors, auto transmissions, robots, pumps, and printers. Plastic gears produced by injection molding are being used more frequently, which places new demands on manufacturing and metrology. Due to varying process parameters, such as the mold fill level or shrinkage, each tooth can theoretically look different, so every tooth must be measured. This makes tactile measurement very time-intensive, taking up to several hours.

Computed tomography coordinate measuring machines (CT-CMM) provide an enormous time advantage. The measurement and evaluation take just a few seconds. As the entire workpiece is always captured, the time required is nearly independent of the number of geometrical characteristics to be measured. Further reduction in measurement time can be achieved by loading several workpieces in the machine at the same time, which are then separated automatically by the software.

The CT always provides a complete measurement point cloud of the workpiece instead of individual scan lines. This means that all teeth can be evaluated at every point, with as many sections as desired, without increasing the measurement time. The captured measurement point cloud can also be used for a color-coded comparison to the CAD model. The volume data that is also generated allows inspection of the gear for voids, for example. The areas of application range from

incoming goods and manufacturing monitoring to quality assurance and development.

Because measuring the gears is not limited by the diameter of a probe sphere, even very small moduli can be measured. Without the mechanical filtering effect of the probe sphere, higher detail resolution can be achieved. CT sensor systems are relatively easy to operate, and the workpiece fixtures are typically easily produced, even for very small gears. The measurement point cloud can also be used for pinpoint analysis and simulation of tactile scanning paths or point distributions. With identical measurement positions, CT measurements can thus be compared with conventional tactile measurements.

The automated analysis of measured data with WinWerth® GearMeasure provides further time savings. The analysis complies with standards and has appropriate filter options to ensure optimal comparability with classical methods. In the WinWerth® 3D measurement software, the teeth can be analyzed with any references desired, based on the subsequent application. For example, teeth on a shaft can be evaluated referring to different datums on the shaft. With WinWerth® GearMeasure, a uniform software solution is available for a wide range of gear types. Spur gears with involute teeth, with or without lead angle, external and internal teeth, worm wheels (ZI, ZA, ZN, ZK, ZX), and any arbitrary profile forms such as cycloid teeth or rotors can be analyzed.

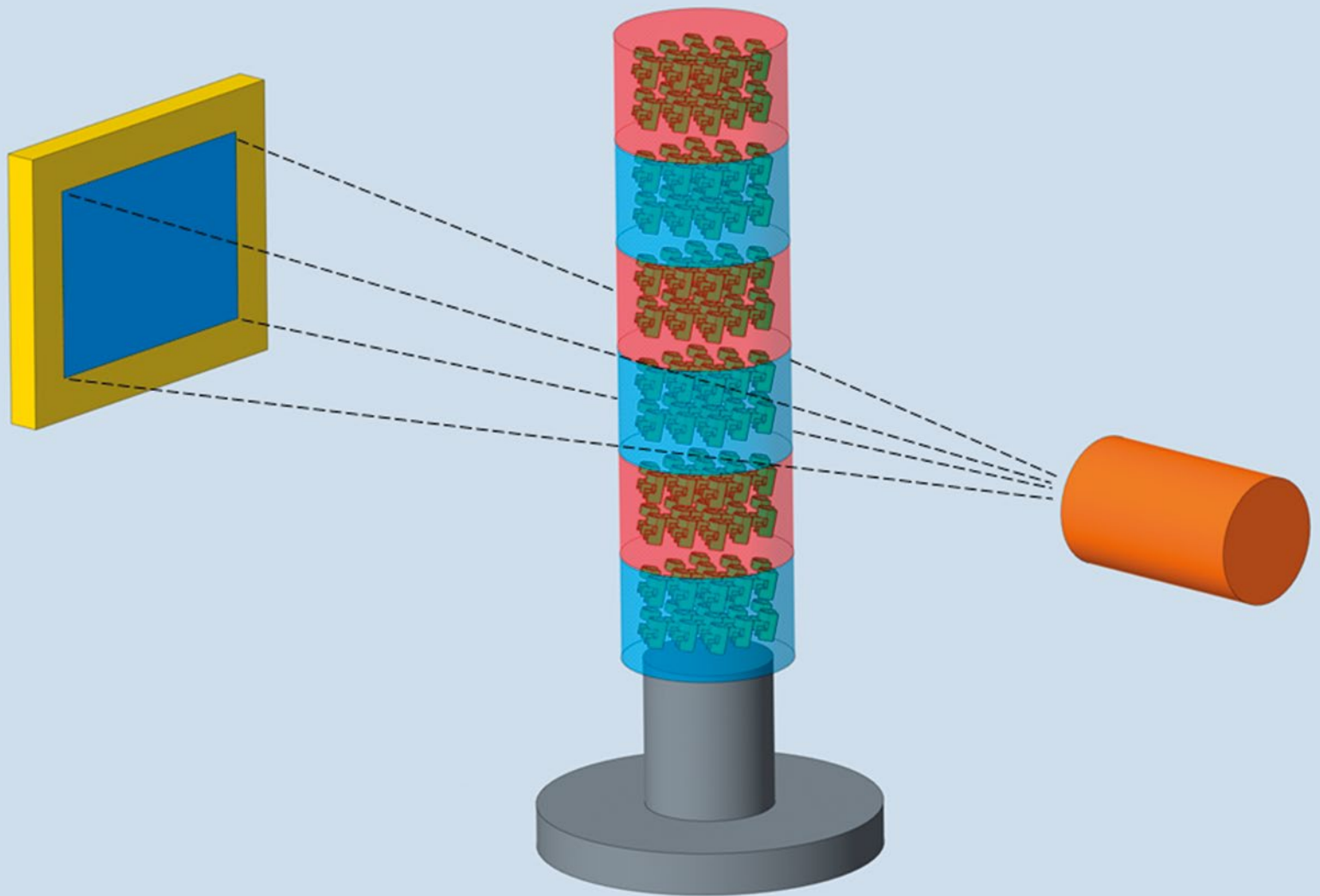

*Raster tomography also allows several fixtures with many small workpieces to be measured automatically together.*



*TomoScope® XS Plus – large measuring range with a small footprint*

## **TomoScope® XS Plus – Compact machine with large measuring volume**

The new coordinate measuring machine TomoScope® XS Plus with computed tomography provides twice the measuring volume of the TomoScope® XS. With Werth transmission tubes, high-resolution measurements are possible at high power in correspondingly short measurement times. The monoblock design of the tube, generator, and vacuum production makes the X-ray tubes nearly maintenance-free, providing extremely high uptime. The open design results in unlimited service life, as wear parts can be replaced. The tubes are available with maximum voltage of 130 kV or 160 kV, covering a wide range of applications for plastic and metal workpieces.

In raster tomography, X-ray images of various workpiece areas are taken sequentially. The workpiece volume is reconstructed from the images at various rotational positions of the workpiece, and the patented sub-voxeling process is used to calculate the measurement points at the material transitions. This process allows larger workpieces of up to about 450 mm in length to be measured. Alternatively, smaller objects

can be captured at high resolution individually or multiple objects simultaneously with reduced measurement time. The measurement results are complete workpiece volumes at any desired resolution in all coordinate axes (up to 60 billion voxels). The measurement point cloud allows both nominal-to-actual comparisons, by means of which problematic regions can be identified at a glance, and the measurement of geometrical characteristics.

The new machine is also suitable for inline applications. This is made possible in part by the reconstruction of the workpiece volume in real time, in parallel with the measurements, by the fast analysis software, and by OnTheFly CT.

With the TomoScope® XS Plus, Werth Messtechnik presents the next generation of compact computed tomography machines. The machine offers a cost-effective overall concept, with low space requirements and weight.

# Werth international – News

## Werth Metrology Ltd.



*New Werth Metrology Ltd. building in Derby*

With the opening of the new sales and service base in Derby, UK, Werth Metrology Ltd., responsible for England and Ireland, continues to grow. On 1 November 2018, the new office was put into operation. Werth Metrology Ltd. offers product demonstrations, product training and seminars in the new premises.

In addition to Paul Nash, Carl Harrison is now the second managing director of Werth Metrology Ltd. Carl Harrison adds: "I am very much looking forward to the new challenges and will be able to contribute my many years of experience with Werth Messtechnik GmbH equipment in my new position."

Since 2018, the team has been supported by Mr. Sam Sadnicki, who heads the back office for sales and marketing.



*From the left: Paul Nash, Carl Harrison and Sam Sadnicki*

## Werth Italia S.r.l.



*New sales staff at Werth Italia: Fabio Boccapanola (left) and Fabrizio Rosa*

The sales team was strengthened in order to be even closer to the customer in the future. With Mr. Fabio Boccapanola and Mr. Fabrizio Rosa, Werth Italia has gained two experienced sales employees who work directly from the main office. In order to meet the increased demand from the market, Werth Italia plans to expand the demonstration center and thus move the company to larger premises towards the end of the year.

## Suzhou Werth Metrology Ltd.



Mr. Yi Feng takes over the position of Technical Manager on the basis of his many years of experience and is now responsible for application and service. Mr. Chang Zhou joins the team as an application engineer with a focus on computed tomography.

*Yi Feng (left), Technical Manager, with the Application Engineer Chang Zhou*

# Werth international – News

## Werth Magyarország Kft.



*Zoltán Szabó, Applications*

Werth Hungary reacts to the current market requirements and strengthens its team in the areas of application and sales. Mr. Zoltán Szabó supports application with his many years of experience, and Mr. Zoltán Ullrich assumes responsibility for product consulting in the Hungarian market.



*Zoltán Ullrich, Sales*

## New logistics center in Giessen

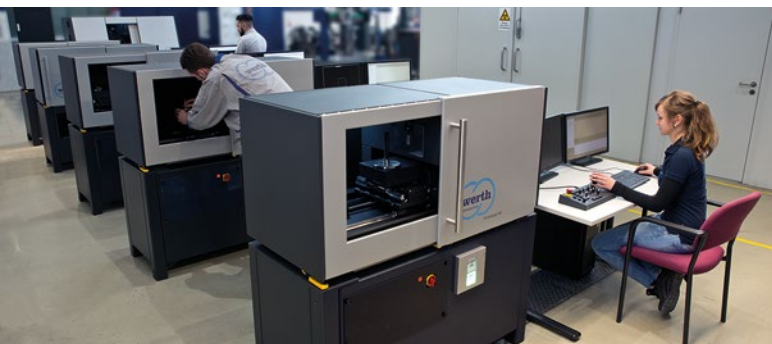

*TomoScope® XS machines at the commissioning in Giessen*

Werth Messtechnik has had its own precision manufacturing and assembly facility in Giessen since 1958. Several extensions in 1996 and 2015 reflect the positive growth of the company and are a clear commitment to Germany as a business location. In 2018, a new logistics center was put into operation, which will take into account the increased requirements for the dispatch processing of the high-precision measuring TomoScope®, VideoCheck® and ScopeCheck® series. The space thus gained in the main building is urgently needed for the production of the TomoScope® XS machines.

## Promotion of young talent



*The award ceremony of the Werth Foundation: Mr. Arno Fink, Chairman of the Board of Trustees of the Werth Foundation; award winner Dr. Stefan Heist and Prof. Dr. Wipf, Dean of the Faculty of Physics and Astronomy at the Friedrich Schiller University Jena (from left to right)*

The Dr.-Ing. Siegfried Werth Foundation awarded two outstanding dissertations in 2018. Dr. Stefan Heist from the Friedrich Schiller University Jena dealt with the topic of high-speed 3D shape measurement using aperiodic sinusoidal patterns, Dr. Robert Kuschmierz from the TU Dresden researched the topic of interferometric laser sensors for three-dimensional, in-situ shape measurement of rotating bodies.

Applications for the Dr.-Ing. Siegfried Werth Foundation Prize or a scholarship, for example as part of a doctoral project, can be submitted via Werth Messtechnik GmbH or directly to the Foundation.

## Credits

The **Multisensor** is the in-house newsletter of  
Werth Messtechnik GmbH  
Siemensstrasse 19, 35394 Giessen, Germany  
Phone: +49 641 7938-0, Fax: +49 641 7938-719  
[www.werth.de](http://www.werth.de), [mail@werth.de](mailto:mail@werth.de)

